

DCC and Layout Power Wiring - Part 2

We have already covered many things in part 1, giving you the background and the theory of DCC wiring, giving you reasons for using the proper wire and telling you how to choose power supplies. We also covered how to calculate power needs. Refer back to part 1 if needed

In this section, we will cover wiring, where and how to lay it - and we'll also try to provide you with the techniques and skills to do the job properly as well. Read on!



Choosing the wire:

If it gets confusing... think about liquid flowing through plumbing! It's actually quite a good analogy as most of the characteristics of wire and the way electricity flows through it has a useful equivalent in water and pipework!

I'll try to add a related comment in each section to clarify the reasoning we provide. In the meantime, I want to demonstrate something that it is important before we start. Wire acts differently depending on how it is used!

- Wire diameter and material both make a difference.
- A wires linear resistance is WAY different with a waveform in it.
- A wires resistance increases as the load on it increases.

Wires vary in length, so I have chosen a length of four metres– actually a very short bus as any DCC type power bus is measured out and back, making it DOUBLE the length most think about!

Wire diameter	Ohms @ 4mtr Low frequency	Ohms @ 4mtr DCC frequency	Ohms @ 4mtr High frequency	V-Drop @ 2 A	V-Drop @ 3 A	V-Drop @ 4 A
#13or 2.5mm ² (say 99*.2 stranded)	0.0905	0.105	0.226	0.429	0.624	0.819
#15 or 1.5mm ² (say 60*.2 stranded)	0.134	0.151	0.307	0.883	1.410	1.188
#18 or 0.8mm ² (say 32*.2 stranded)	0.176	0.188	0.363	0.742	1.132	1.522
#20 or 0.5mm ² (say 16*.2 stranded)	0.394	0.414	0.605	1.681	2.497	3.315

**Note: Wire quality varies a lot, not all wire is pure copper & some will have more voltage drop!
* The resistance is VERY different as frequency changes * wire diameter makes a BIG difference!**

Also please remember as you read this, these values are for wire with no joins or connectors - and every time you add a joint or connector, you will add resistance and increase voltage drop, no matter how good you are.

What's more, if you use screw terminals/crimps, the resistance in all joints exposed to air will increase over time... so "Solder everything" and "Best practice to start with" are great policies to follow when you build your layout!

As always, we prefer to keep it simple... so "That's it for the theory" in this section:

If you want to do calculations based on your own layout then go ahead, but from now on in DCC and layout power wiring part 2, we are simply going to say what should be used and how to use it to get the best result, so "just do this" will replace all of the tech talk.

(Those who want more detail - Google is your friend.)

If like most, you just want good information, help and guidance so you can get it right, then be confident... We guarantee that if you follow guidelines and use the right stuff, it will all work fine!

DCC and Layout Power Wiring - Part 2

Continued...

Back to wire choices, wiring configurations and where to run the wires - As always this is "good practice" to guide you... Follow similar principals and YOUR layout will always perform well.

These diagrams illustrate several principals that are important in medium-to-large layout wiring.

They represent a medium to large E shaped layout with track that generally follows board outlines, and the use of a handset-type system with multiple plug-in points. Scale makes no difference, we work in real dimensions and real power when wiring a layout!

Version 1: A big layout needing multiple boosters.

This includes the breaking down of the main power bus into three "Power Districts" & shows the use of a main control system plus multiple power boosters. This is the ideal way to wire a large or VERY busy layout that will have super-heavy train traffic that DOES need the added power that boosters will provide.

Boosters receive data from the control bus (blue lines) and then distribute power via their individual power or track bus (deep red lines). When multiple boosters are used, each has its own short-circuit protection so unless the power districts are large, added protection is NOT needed.

- 1- The Power or Track bus (Red Lines) should generally follow the track flow.
- 2- The Data or control bus should be run as far as is practical, away from the track bus.
- 3- Where power and control bus have to cross, they should ideally do so at right angles.

Of course, most layouts are not so regular.... Tracks cross over each other and tend to wander a little, so please interpret it in relation to your layout.

Please note: The triangles represent controller plug-in points or "UTP" panels. Gaps are shown in red/yellow.

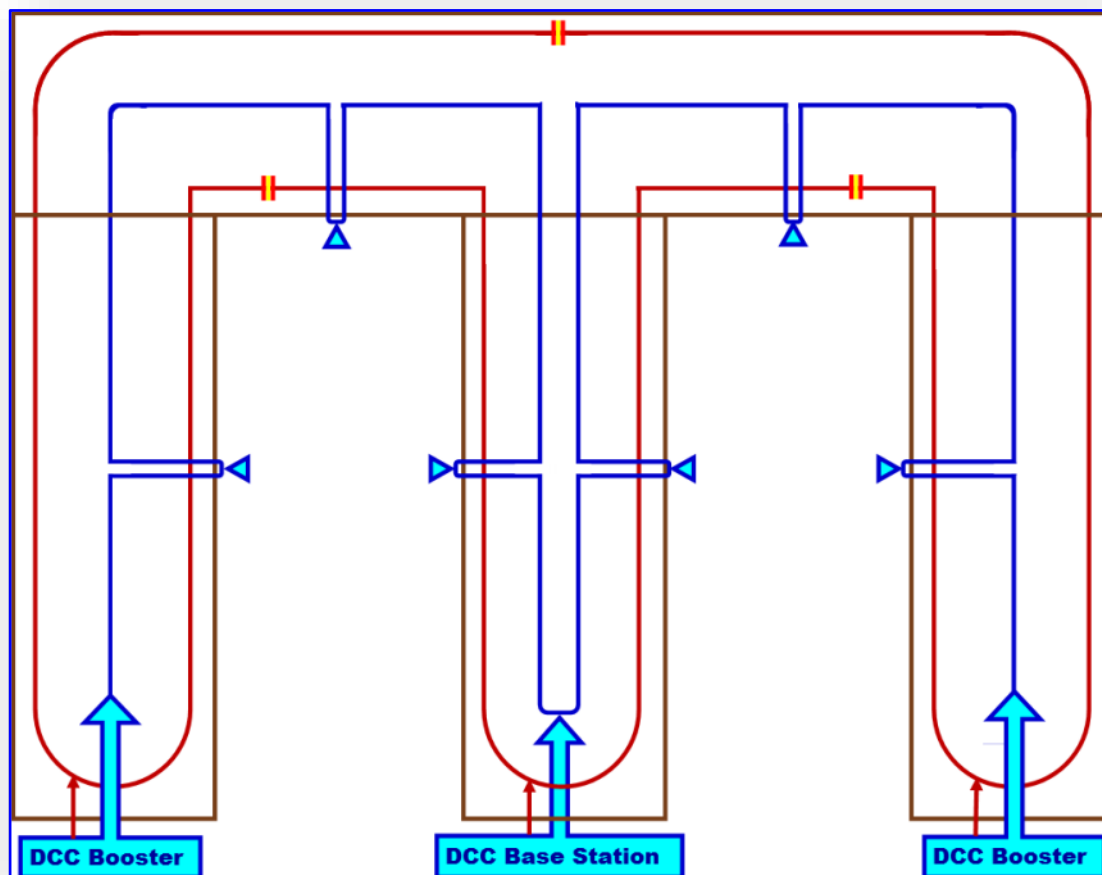

DCC and Layout Power Wiring - Part 2

Continued...

Version 1: A larger layout needing only one main unit, but divided into power districts.

This includes the breaking down of the main power bus into three "Power Districts" & shows the use of a main control system plus multiple "DCC Circuit breakers". This is the ideal way to wire a medium/large layout that **WILL NOT** have super-heavy train traffic and so does not need more boosters.

The base station sends data to the main power bus directly (Orange lines) and receives data from the handsets via the control bus (blue lines).

We have broken the layout into 3 power districts. Each power district has its own DCC circuit breaker, which is in turn connected to its own track power bus so that it protects all track under its control. If one area has a short circuit, it will shut down but other areas will still get power.

This layout can also use the orange wires (connected to the controller track outputs) as a separated "DCC Accessory power bus" for all of the layouts DCC accessories. If the DCC short circuit protectors on each of the separate power districts is set to a level below that of the main system, a track-based short will not shut the system down so accessories (and the other power districts) will still have power even if there is a problem with a train!

- 1- The Power or Track bus (Red Lines) should generally follow the track flow.
- 2- The Data or control bus should be run as far as is practical, away from the track bus.
- 3- Where power and control bus have to cross, they should ideally do so at right angles.

Of course, most layouts are not so regular.... Tracks cross over each other and tend to wander a little, so please interpret it in relation to your layout.

Please note: The triangles represent controller plug-in points or "UTP" panels. Gaps are shown in red/yellow.

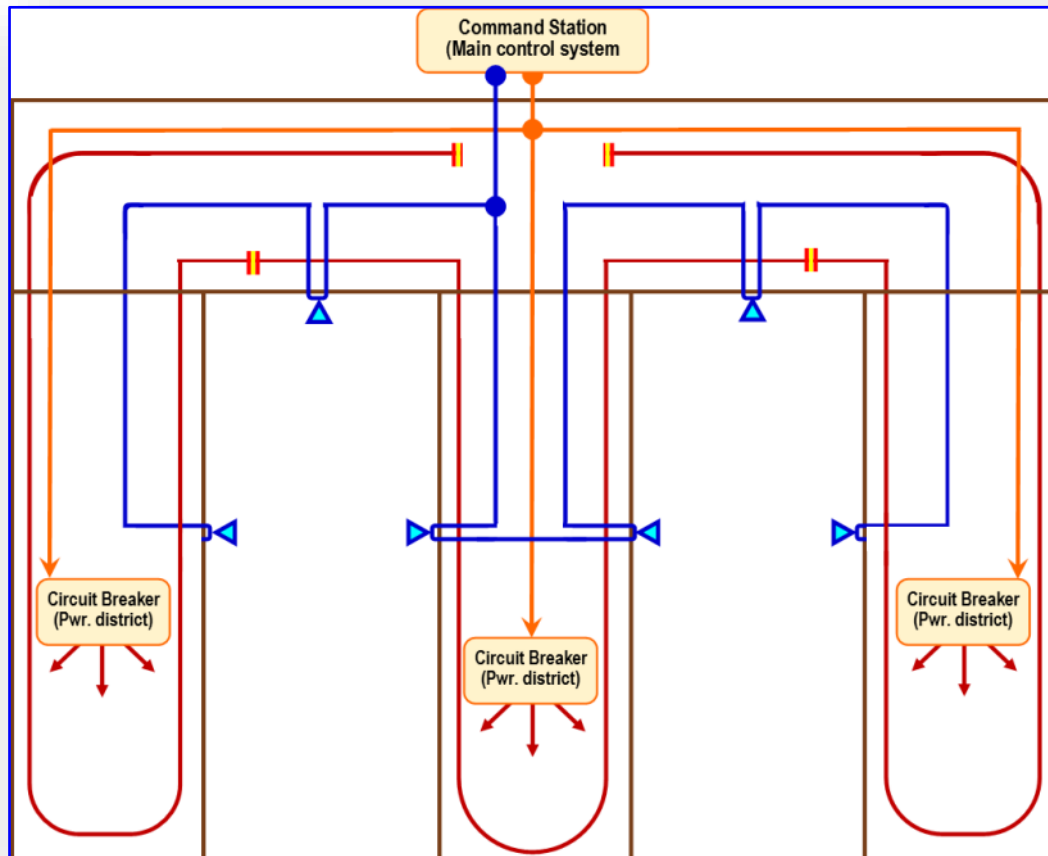

DCC and Layout Power Wiring - Part 2

Continued...

Now, lets look at a more realistic layout. This plan is actually only one level of a multi-level layout that's been slightly modified to use as an example... but its big enough as it is to qualify as a "Medium to large" layout in HO/OO and so is of a commonly built size. It's not all that exciting as a layout - but the general 2-layer track run is interesting and it could be reformatted to become a useful design.

Back to its purpose as a demo though... As a base for discussion, it's interesting as it has TWO potential reversing loops - One is a conventional loop on the right-hand side. The other is a "Wye" - a Y shaped junction that is commonly used as a turning area or as a bi-directional entry to a terminus. I've used this example because it covers two important wiring principals in relation to planning for reverse loops! **The tear-drop shaped reverse loop is on the Grey line, The Wye link in this diagram, which will need an Auto-Reverser, is Purple.**

1- Definition - "Reverse loop". A reverse loop is any track configuration that turns back onto itself or that, when traversed, can result in a train that travels on it returning to its start point facing in the opposite direction.

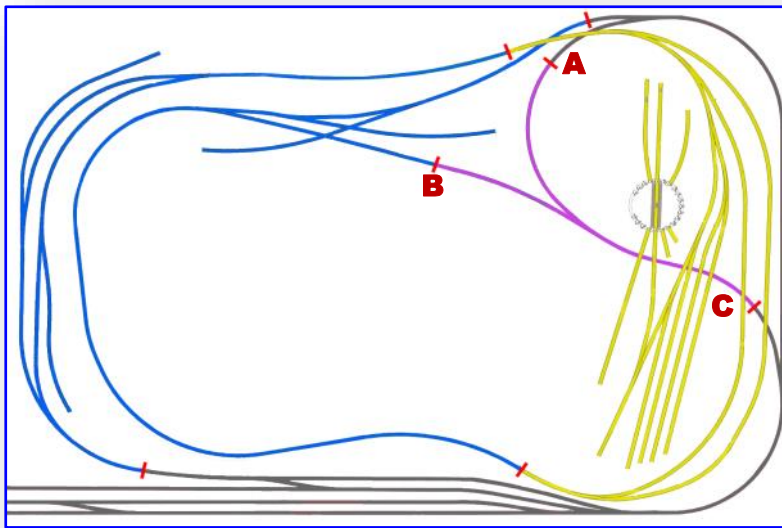

(Reverse loops come in various guises. Some that come to mind are Diagonals, dog-bone shaped layouts, Teardrop loops, Wyes & Turntables)

2- Look carefully: It is not always as complex as it looks! In this case, instead of two auto-reversers which might be what we used if we didn't think it through, we can do it with one, because they have common trackage. The purple area represents both the loop and the wye... so as long as we double gap where shown (red bars) we can get the result we need with ONE auto-reverser

3- Reversing loop tracks have rules! They must always be a little longer than the longest train that will run through that section. This is because Auto-reversers react to the electrical phasing difference when track folds back onto itself to form a loop. If a train bridges both ends of the

loop track at once, it can send conflicting signals to the Auto-reverser, which can only react to one at a time!

4- Think about traffic flow before deciding. When you plan a reversing section on a busy layout, then its also important that only ONE train enters and leaves the reversing section at the same time for the same reason... so while you CAN sometimes save \$\$\$ by sharing an Auto-reverser between two reversing areas, you really need to think about train movement before you do it!

5- Always Isolate BOTH rails on all legs of any Auto-Reversing Section. We've done this already. You can clearly see the places that we chose for the gaps marked with red lines at A, B and C on the drawing.

6- OK, what IS an Auto Reverser? An Auto Reverser is a clever electronic device that is installed into a track section that forms part of a reversing loop or section. It senses the momentary short-circuit or "phase error" when a trains wheels cross the gaps, and instantly changes the track phase in the section it is connected to, so that it matches the section that the train is entering.

7- How do I wire one in? It is really easy - two wires in, two wires out. It takes power from the track bus to its inputs. Its outputs are connected to the section of the reversing loop that you selected.

9- How do I choose the right one? It must be electronic. Some older Auto reversers by MRC / Lenz / Digitrax used relays and were too slow. Avoid them. We recommend the PSX-AR which is reliable and includes added overload protection for the reversing section too.

Click on the PSX-AR picture to learn more about it.

The PSX-AR

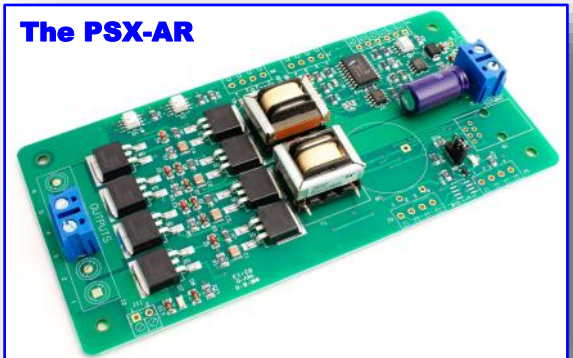

DCC and Layout Power Wiring - Part 2

Continued...

Now, lets look at this layout again.

This time we will look at it as a more practical example of layout power management.

We have made the basic layout "half-tone" so it doesn't get in the way, and overlaid four heavy coloured lines to represent possible "Power districts". You can use the same principals for ANY layout design!

Blue covers much of the main running line:

Yellow covers the terminus area and Loco facility

Grey covers the yard and associated main line area:

Purple is the reversing section

Schematically this is actually pretty simple.

The DCC system feeds the main power bus, and each of the DCC circuit breakers/reversers feeds its own "Sub Power Bus". Use the main power bus as the DCC Accessory bus and leave it at the default protection level of the DCC system. Set all associated breakers/reversers to 75% or less of main system power.

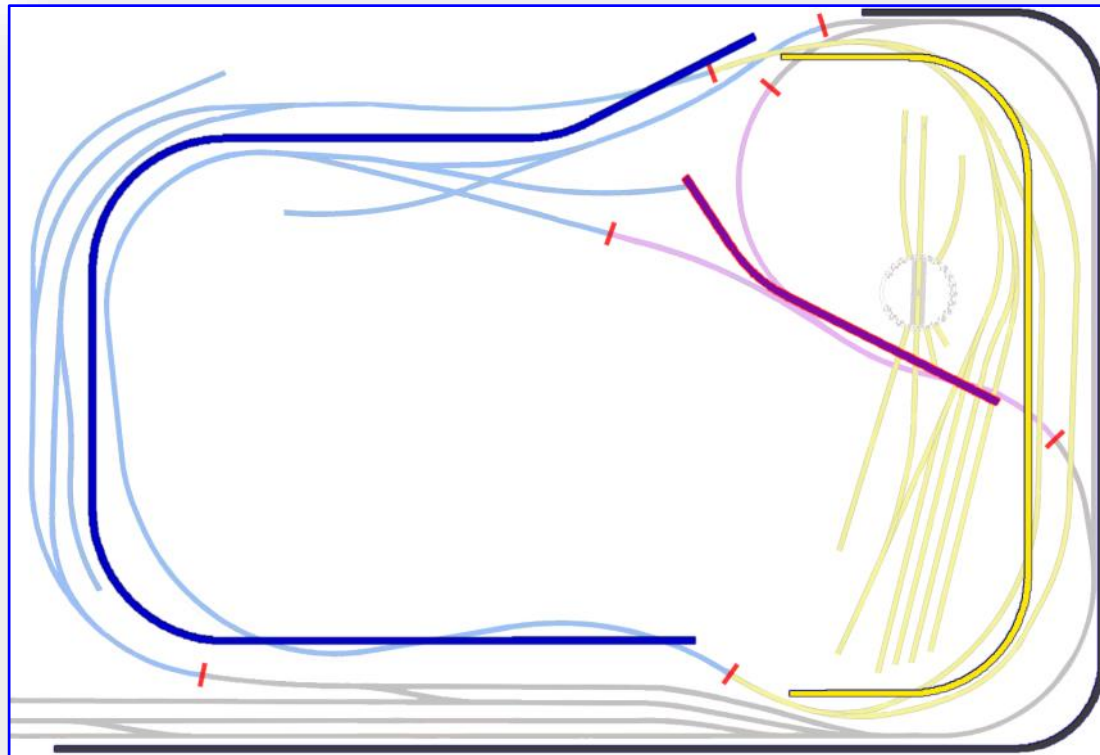
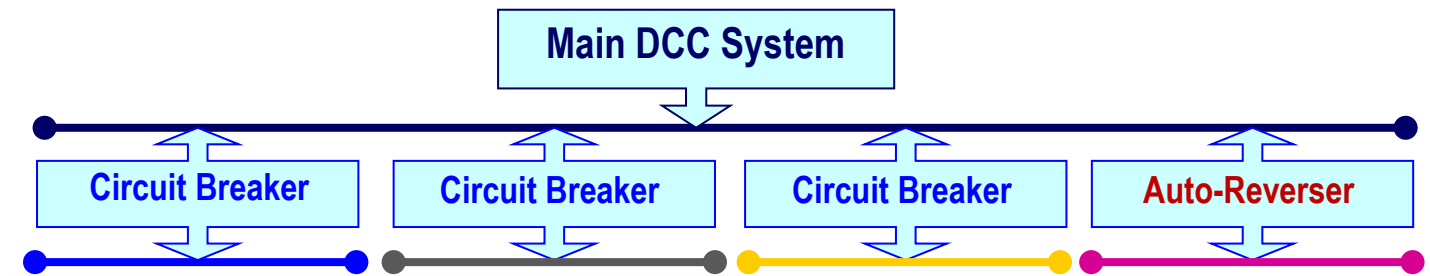

PSX-1 Circuit Breaker

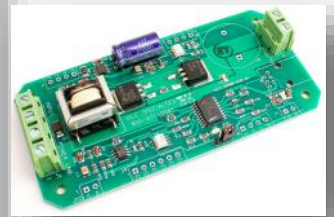

PSX-AR Auto-Reverser

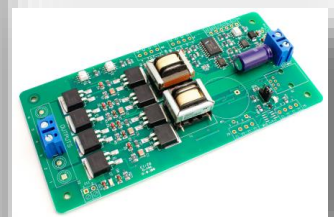

Understood? Good... Take your time and apply this approach to your own layout.

DCC and Layout Power Wiring - Part 2

Continued...

BASIC DCC Layout Wiring: *not all layouts are that big!*

We have covered much of this subject in earlier pages so for those with less grandiose plans, we will take a look at a generic smaller type home layout which could be created from either set-track or flexi-track.

A reversing loop is also shown as this is a common problem for modellers. Our diagram includes an auto reverser and one of these is included here. Droppers are indicated by blue & red triangles, gaps are represented by green lines.

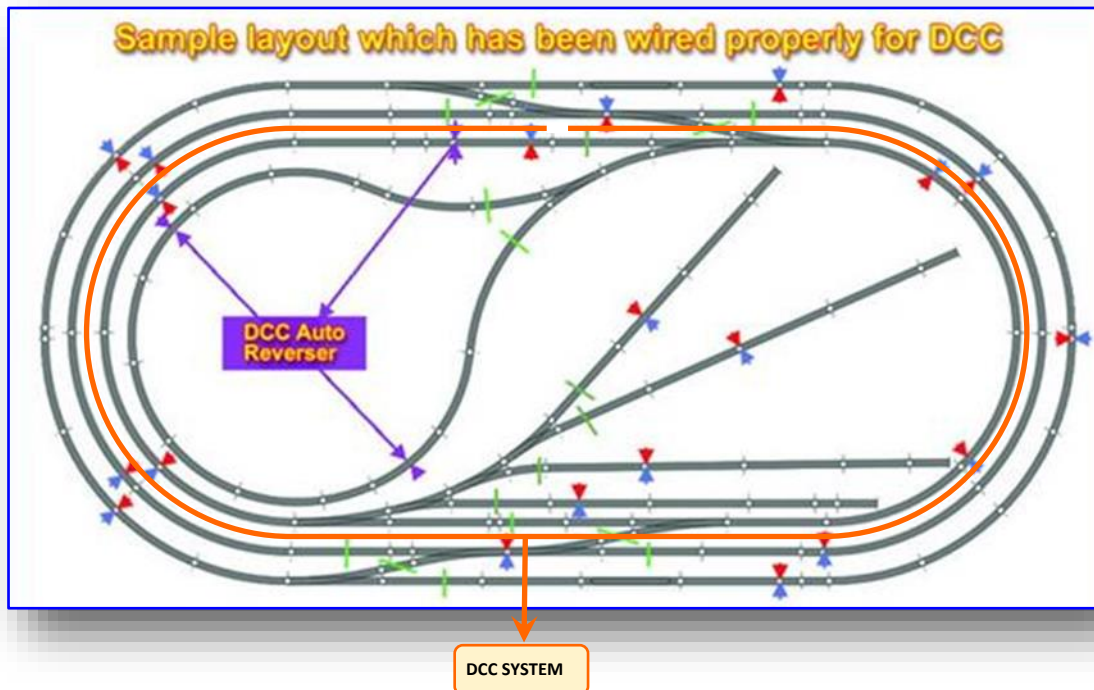

The **ORANGE** line is the Power Bus

The track feeds that are via the auto-reverser are shown with purple lines and triangles.

Wiring advice for both set track and flexi-track is precisely the same, that is, it is best to use a T shaped bus and while its not so important for small layouts, it is strongly suggested that you do NOT form a complete a ring as this can cause problems with larger or more "digitally busy" layouts. Always use good quality wire of the right size and don't skimp on the number of droppers used! (Important, especially on set-track layouts where rail joints are far more frequent).

(A "T" shaped bus for this layout would generally follow the main in a loop, but NOT close the ring totally. It is shown in orange. You can see the gap in between the two upper crossovers. The DCC control system should be placed about half way along the bus so left and right branches are equal - as per the drawing.

It is of course impossible to cover every possibility in a single example however hopefully many of your questions are answered in this one drawing - However if you have a specific problem or cannot find an answer to your own layout problem in these pages, please do feel free to email us at sales@dccconcepts.com and ask - we will be happy to help.

What size of wire would we recommend for this layout?

Power bus wire should ideally be twisted 12 turns per metre. Pre-twisted wire is available from DCCconcepts

(The power bus used here should ideally be 1.5mm or appx 15 gauge and droppers between 17g/1.0mm and 20g/0.5mm. The absolute minimum if its not going to grow any larger is 17g/1mm power bus & 22g/0.33mm Droppers.

This is a simple example of a small layout. The ONLY thing we have not covered here is the running of power bus and control bus or low power digital wiring. This is because this small layout is unlikely to need any!

Larger layouts do have both high and low power bus wiring - so we will cover that in the following pages.



DCC and Layout Power Wiring - Part 2

Continued...

We have talked about wire characteristics, how to wire and we have given you some guidance in relation to where to put it when you wire your layout...

Now it is time to move on to how to choose the wire and how to install it. With the theory covered, we will keep this part pretty simple.

Choose the right wire for the best result:

A chart is the best way to present this.

A Power bus is really the “out and back” length of the two wires. This is the meaning of Power bus length when we refer to it in the chart.

Bigger wire is always better for the Power Bus. It really is impossible to have wire that is “too big” electrically, however there WILL become a limit in that some wire is hard to work with and it needs huge energy for soldering truly over-size wire.... Or really big connectors.

It's up to you of course—but we strongly recommend that you follow the guidelines in the chart!

Wire type Layout Size	Twisted 12 turns per metre 17G/1mm ²	Twisted 12 turns per metre 15G/1.5mm ²	Twisted 12 turns per metre 13G/2.5mm ²	Twisted 12 turns per metre 11G/3.5mm ²	Dropper Wire 26x.015mm ²
Small to Medium-small (P/BUS = 2~6m Max)		OK	OK	OK	
Medium/Bedroom sized (P/BUS = 7~12m Max)	Marginal		OK	OK	
Larger/Garage sized (P/BUS = 13~20m Max)	NO— to small!	Marginal		OK	
Double garage/Bigger (P/BUS = is Over 20m)	NO— to small!	NO— to small!	Marginal		

CLICK on the chart to be taken to the DCCconcepts Wire range

Droppers:

We are often asked about the size for droppers. Here is a quick over-view.

Droppers are usually short. Short wires have very low voltage drop and the most important thing is to match the dropper size to the job it's being asked to do. Here is a quick/safe (conservative) guideline of diameter vs length.

DCCconcepts 26x 0.15mm Dropper wire: OK to 1.2 metres (4 feet)

Standard 16 x 0.20mm heavy hook-up wire: OK to 750mm (2.5 feet)

Standard 7 x 0.20mm light hook-up wire: OK to 450mm (1.5 feet)

Solid vs Stranded wire:

We are asked about this too. Technically it does not matter.

We prefer stranded because solid wire can be stiff and much harder to work with - Also, if you are not very careful with the wire stripping, and you accidentally nick the core of solid wire, then it WILL break if you bend it or move it.

DCC and Layout Power Wiring - Part 2

Continued...

Before we finish this section... lets talk about how to make the process easier. None of us enjoy too much time bent double under the layout after all.

Believe it or not, it is NOT a difficult process and with the right tools and techniques & with the odd "tip" thrown in, it can become, at the very least, a satisfying process - In fact for some it will become a job to look forward to and enjoy, rather than dread!

As always, lets start at the beginning: The tools and materials to do the job.

Wire: Always use good quality wire, and please don't be tempted to re-use second hand wire that is not in new condition. We gave you the range and specifications for wire earlier - [here is a link to the right stuff!](#)

Solder: Use only the best available. Use that old roll you inherited as wagon weights or something, because it is already well past its use-by date and not as good as it was when new. We formulated it to be the best and it is, so we guarantee that if you use our [DCCconcepts S179 solder](#), the whole process will be easier.

Flux: Yes, there is flux in the solder but its not enough. Use Our [Sapphire No-clean flux](#) and you will be amazed at how much better the solder flows when tinning wire, soldering droppers to the rails or to a power bus!

Strippers: Forget faffing around with a blade to strip wires. Use the right strippers for the job. It will let you do a better job and will literally save you hours of work, as well as saving your fingers from many small cuts and teeth from some painful experiences. **Use the right strippers and you will never compromise again!**

There are two types needed to cover everything you will need to wire in the hobby, but for layout wiring you will need only the DCCconcepts [Bus wire strippers](#) (for decoder work, [Our Fine Wire strippers](#) are unequalled).

Soldering Iron: There may be "good ole soldering Irons" but there are NO good, old soldering Irons! They do not last forever, sorry. If the tip is a pointed one, if it is not bright and shiny or if it takes an age for the Iron to heat up, then it will NOT do the job. Old Irons are also dangerous, as their internal insulation breaks down over time.

Ignore those who try to tell you that a 25 watt Iron is all you need. They are wrong. You will need a 50 watt Iron to solder droppers to the Power bus AND to do a good, quick job of soldering droppers to the rails.



Modellers often expect that we will suggest a base-station type Iron for this job but while it is nice to sell expensive soldering Irons, we do not, because it's not really the most convenient kind of soldering Iron to use for wiring - the base gets in the way!

This 50 watt Fx600 Soldering Iron is the perfect choice - & top quality too.

We also stock spares & tips for it so keeping it ready to go will not be a problem! We also supply the FX600 to you with a second tip - It is a C2 type, the perfect style for wiring and soldering droppers to rail!



DCCconcepts "Bus wiring tags": These tags are the key to tidy wiring and easy dropper attachment. Once used in early electronics, they are almost impossible to buy now so we had them re-tooled and re-made for us so the price is way lower than at those few electronics stores that DO still have them! They hold the bus tidily in place and permit you to install droppers anywhere, any time. Without doubt, this is the best possible way to create a neat and tidy power bus structure for your layout.



We show you how to go about it on the next 3 pages!

DCC and Layout Power Wiring - Part 2

Continued...

Use these techniques and you WILL become a wiring and soldering expert!

What's more, by doing it right and utilising our DCCconcepts TAGS for us installation & dropper connections... you will never need to cut the power bus, so with no need for resistive joints, power delivery on your layout will always be at its best.

Tools needed:

Soldering Iron, Small file and/or Fibreglass brush. DCCconcepts fine wire strippers.

Materials needed:

Sapphire 179 solder, Sapphire no-clean flux, Red/Black/Green dropper wire. Track and turnouts. Damp sponge.

~~~~~

**#1 - Preparing the Droppers for use.** Pre-set some DCCconcepts fine wire strippers so that they cut through the insulation without nipping the wire strands. Lock them in the set position. Use the strippers to cut through the insulation around 15mm from the end of the wire **(A)**.

**Do NOT pull the cut end off with the strippers - instead, grip the cut end with your fingers and twist clockwise as you slowly pull it off.** This will guarantee a perfectly tidy tightly twisted wire with NO loose strands (That's how the pro's who make high-end control panels do it).

**Make sure your soldering Iron is hot and the tip is shiny.** Have a damp sponge handy. Wipe the tip on it before every use, so it can transfer heat properly. (If it is not shiny, re-tin or replace it before you start)

**Apply no-clean flux liberally. Using Sapphire 179 solder, tin the wire.** (It will flow well thanks to the flux)

**Bend the end of the tinned wire to 90 degrees 10mm from the insulation **(B)**. Nip off the end to leave an L shaped end about 2~3mm long **(C)**.** This will be the bit of the wire that we will solder under the rail.

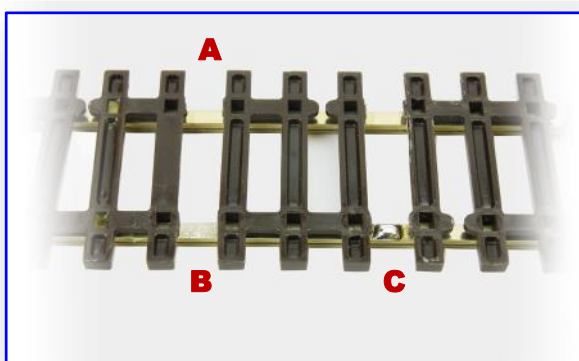
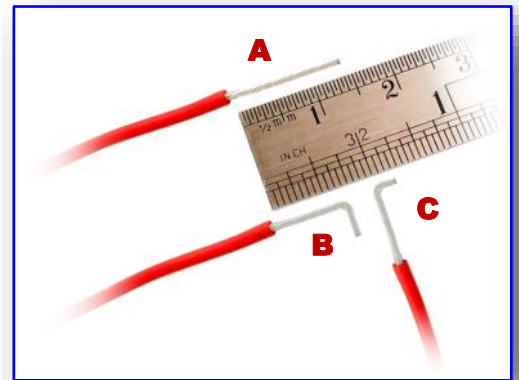

**#2 - Prepare the track or turnout.** Decide where the dropper will go. If needed, remove the web from between two sleepers, exposing the bottom of the rail. Rail oxidises even when new **(A)**, so clean it well **(B)** using a file (the quickest way) or fibreglass brush.

**Apply flux liberally.** Using Sapphire 179 solder, tin the bottom of the rail **(C)**. You don't need much solder at all. If your soldering iron is OK and you use DCCconcepts S179 solder and "No clean" flux, , this whole process should take no more than ONE second. (The solder will flow well & coat the rail evenly thanks to the addition of flux).

**#3 - Soldering the Droppers to the rails.** You have already prepared the dropper in #1 above. **Add more flux to the tinned area of the rail.** Hold the L shaped pre-tinned end of the dropper onto the pre-tinned bottom or under-side of the rail. Wipe the soldering Iron tip on the sponge then add a little solder to it.

**Apply the hot Soldering Iron tip to the joint and the solder will flow almost immediately.** If the Iron is up to the job and you use the right materials as above, it will flow in less than 1 second! As soon as the solder flows, remove the Iron, hold the wire still and count to 3.

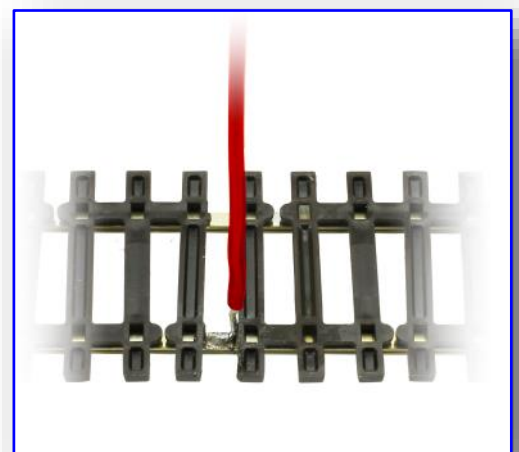

**It's done - You have made a perfect dropper joint!**

## DCC and Layout Power Wiring - Part 2

*Continued...*

**Making wiring the DCC power bus much easier - with ZERO cuts to the main bus!**

**The DCCconcepts bus wiring system, using "Bus wiring tags":**

As we said on the previous page, these tags are the key to tidy wiring and easy dropper attachment... they fix the power bus in place too!

**What's more, you'll never need to cut the power bus, and with no need for resistive joints, power delivery will always be at its best.**

**Tools needed:**

Soldering Iron, Power Bus Strippers, Cutters, screwdriver.

**Materials needed:**

Tags, solder, flux, dropper & bus wire, #4~6 x 12mm screws.

(We have added direct links [Like This](#) to any items mentioned)



**For soldering advice, see the last page of THIS article or our "Soldering Advice" pages.**

***OK... Let's get started. First we need to prepare and get some pre-wired track laid!***

The baseboards are done and the [closed cell foam track-bed](#) is laid and ready for the track... but before we lay the track - lets prepare properly. If we do, it will save LOTS of time and effort

**MOST important thing to do - We will get the droppers sorted out BEFORE we lay the track!**

**Step 1- BEFORE you start to prepare to lay the track...** Work out where you will run the power bus.

Think about where it will run relative to the track. Try to run it so that the average length dropper will remain less than 450mm (the odd exception is OK if you use [our](#) dropper wire which will cope with longer)

**Step 2 - Pre-cut a few 450mm droppers [from red, black and green dropper wire](#)** and prepare them. How to prepare the droppers is discussed on the previous page (p9) of this article.

**Step 3 - Prepare the first turnouts.** Do the modifications for live frog use / switching of frog polarity as shown on page TWO of our "Improving Peco Point-work" article. (similar prep works with all live frog turnouts).

Then, reconfirm which way they will sit on the layout so that you will get the correct wire on each rail. Mark with permanent marker. Add a Green dropper to the frog. Red dropper to the right rail. Black Dropper to the left rail.

**Step 4 - Prepare the first lengths of track.** Place them on the track-bed. Bend, cut and adjust as needed. With a black or red permanent marker, mark the tops of the rails where the droppers will go. Coding it helps... maybe one mark for the red rail, two for the black. Mark the track bed it sits on at that point too.

**Step 5 - Add the Droppers.** Follow the [soldering advice on page 9](#) and add red and black droppers.

**Step 5 - Lay the track.** Pre-drill dropper holes in the track-bed where you marked (step 4) so that they'll be under the rail . Add neat PVA glue to the first 4 sleepers of each length, & to 2 sleepers each side of the droppers... then every 4th sleeper. It only takes a few seconds with a small nozzle on the glue. Feed the droppers through the holes you drilled and lay the track in place. Add weights to hold it secure while the glue dries. Move onto the next section.

**This image shows us laying track to our PowerBase equipped test-track. Droppers are pre-soldered and holes drilled ready, so once it is in place, it is ready to connect to the Power Bus!**

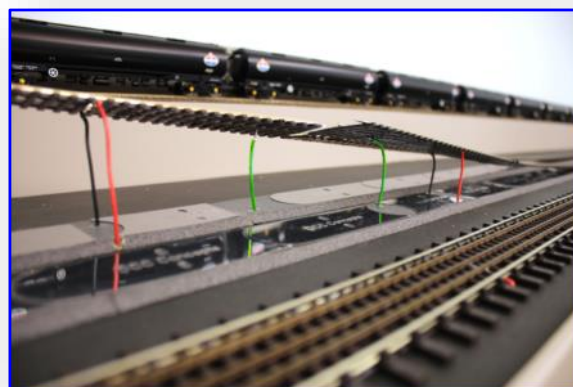

**We explain how it's done on the next page >>>**

## DCC and Layout Power Wiring - Part 2

### Adding droppers to the Power Bus the EASY way using DCCconcepts TAGS:

Here's a tidy, easily managed way to connect the Droppers to the power bus. It works beautifully with any sized layout in any scale... and the power bus never gets cut so wiring resistance is as low as it possibly can be.

It uses DCCconcepts TAG strips which we sell in packs of 25 or 50.

The tools that will help to make it very easy task... are the excellent DCCconcepts [Power Bus strippers](#) and our exclusive [fine wire strippers](#), plus our [track cutters](#) used for snipping the tag strip loops.

### We've already added the droppers to the track, so the rest is easy.

**Step 1 - Decide approximately where the Tags will be mounted.** This is the path of the Power bus and you should place Tags wherever droppers will need to be attached. 2 or 3 droppers can be attached at each Tag if you plan well. (Especially in places where there will be parallel tracks or close to turnouts/point-work where droppers and frog wiring need to be attached.



**Step 2 - Mark the power bus where the Tag will go.** Then use the "Bus wire strippers" to create some clear bare wire in the right place by pulling the insulation of both wires of the power bus apart at that point.

**Step 3 - Take a Tag, and snip the end of the left and right loop.** The image shows what we mean here.

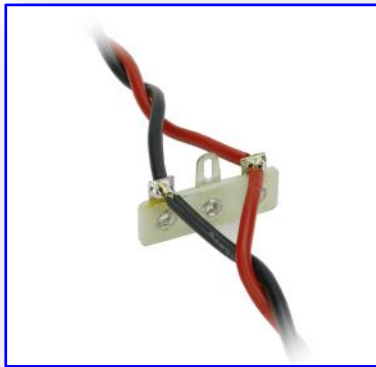

**Step 4 - Insert the bare area of the power bus into the loops.**

When that is done, you can close the loops again. Solder the bus wires to the Tag loops. The image shows what we mean here. Neat and tidy isn't it!

Now you have the bus soldered to the Tag, you can position the tag with just the right amount of tension on the power bus to keep it tidy. Screw in place.

**Step 5 - Decide which droppers will be soldered to that tag.**

Arrange them, cut to length, strip and tin them. Insert them into the correct "Tag eyelet hole" and solder in place. Red to Red, Black to Black.

**Step 6 - Repeat with Turnout Frog wires.** The wire from the turnout can go into the centre "Tag eyelet hole" and the wire from the Accessory decoder or Cobalt Point motor can go into the upper centre loop.

For those wanting more, here's a blow-by-blow description.

- A-** The two power bus wires go here.
- B-** The frog power wire goes here (from Accessory decoder or from the Cobalt turnout motor switch)
- C-** The droppers go here. Match them to the bus colour
- D-** The wire to the Turnout frog goes here
- E-** Tag mounting hole. Use #4 or 6 (2.5 to 3.5mm x 12mm screw)

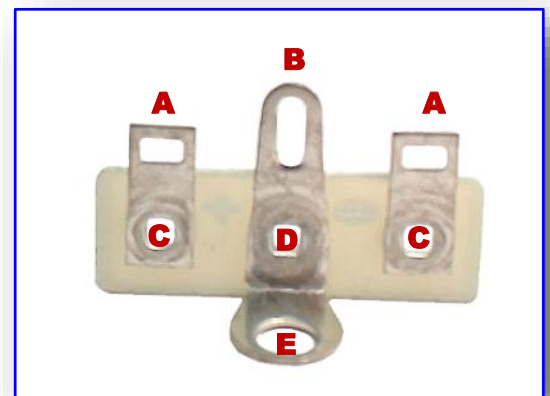

**You're making real progress! Excellent.**

**Now you can move onto the next Tag, and repeat the process... having fun yet?**

*Part 1 and 2 have covered power supplies and main wiring, so by now you will have the basics...*

*In DCC and layout Power Wiring Part 3, we will take a look at creating a control panel - and some of the devices and gadgets you may need to connect when you wire your layout.*